

HARVIA MODULO

HMD1604G

The Harvia Modulo electric heater has been designed to tolerate and provide fantastic heat and steam. The sleek design and open stone surface of Modulo create an impressive sight.



Features

Main material : Steel

H x W x D : 805.0 x 550.0 x 550.0 mm

Net weight (kg) : 46.1

Installation location : Floor

ID	GTIN	Output (kW)	Sauna room size min - max m3
HMD1604G	6410082614332	16.5 kW	15.0-25.0

Related products



HMD1



HMD3

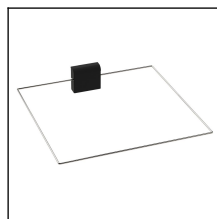

SFE-500500



HMD2



HMD4

Spare parts

Product	ID	Pcs
Adjustable leg	ZSA-440	
Box for Modulo	ZLE-210	
Heating element 2260W 230V	SPZCU-823	3
Heating element 3000W 230V	SPZCU-830	3
Temperature sensor (135C limiter) with cable white	SP255	1

Technical details

Technical data	Type / attribute	HMD1604G
Technical data	Color	Black
	Power output	16.5 kW
	Stone amount (kg)	160
Dimensions	Product width	550
	Product height	805
	Product depth (mm)	550
	Net weight (kg)	46.1
	Gross weight	49.1
	Package width	590
	Package height	910
Safety and installation dimensions	Package depth	640
	Safety distance front (non-combustible materials)	100
	Safety distance front (combustible materials)	100
	Safety distance side (non-combustible materials)	100
	safety distance to the side wall (combustible materials)	100
	Safety distance behind (non-combustible materials)	100
	Safety distance (Ceiling)	1200
	Room min. height(depends on connections and therefore from output, star/delta)	2100
Installation opening height	2000	
Installation opening width	750	
Installation opening depth	790	

Technical images

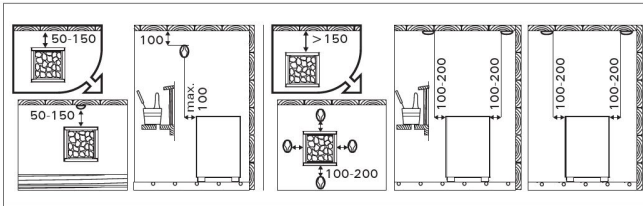

Installing the sensor (all dimensions in millimeters)

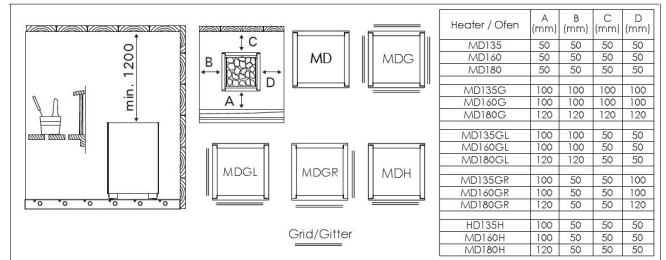

Minimum safety distances (all dimensions in millimeters)

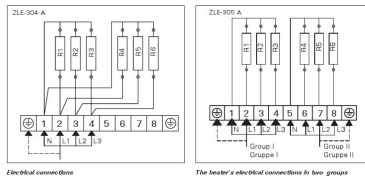

Electrical connections The heater's electrical connections in two groups

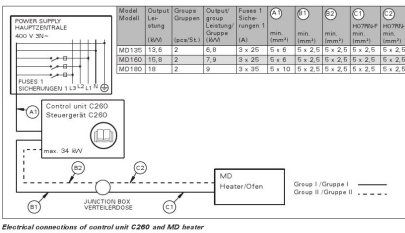

Electrical connections of control unit C280 and MD heater

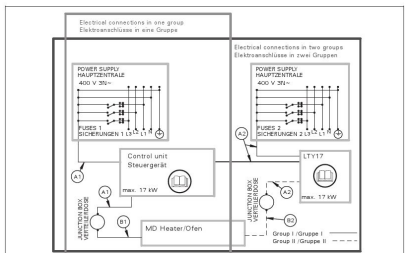

Model	Output Leistung (kW)	Output Group Leistung (kW)	Fuses 1 Schmelzen (A)	Fuses 2 Schmelzen (A)	HD760-F min. (mm²)	HD760-F max. (mm²)
MD135	13.5	1	5 x 2.5A	5 x 6	5 x 2.5	5 x 2.5
MD160	16.0	1	5 x 2.5A	5 x 6	5 x 2.5	5 x 2.5
MD180	18.0	2	3 x 16A	5 x 2.5	5 x 2.5	5 x 2.5

Electrical connections of control unit and MD heater

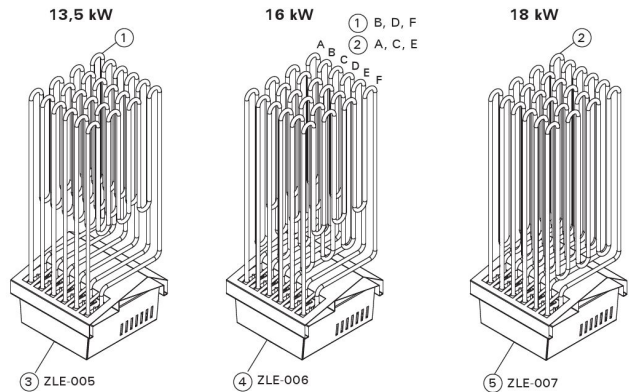

1	Vastus/Värmelement	Heating element/Heizelement	Нагревательный элемент/Кüttelemendid	2260 W / 230 V 2260 W/230 V	ZCU-823	13.5 kW	6 3 (B, D, F)
2	Vastus/Värmelement	Heating element/Heizelement	Нагревательный элемент/Кüttelemendid	3000 W / 230 V 3000 W/230 V	ZCU-830	16 kW 18 kW	3 (A, C, E) 6
3	Vastuspaketti/Värmeelementspaket	Heating element module/Heizelement-Modul	Модуль нагревательных элементов/Кüttelemendi moodul		ZLE-005	13.5 kW	1
4	Vastuspaketti/Värmeelementspaket	Heating element module/Heizelement-Modul	Модуль нагревательных элементов/Кüttelemendi moodul		ZLE-006	16 kW	1
5	Vastuspaketti/Värmeelementspaket	Heating element module/Heizelement-Modul	Модуль нагревательных элементов/Кüttelemendi moodul		ZLE-007	18 kW	1

We recommend to use only the manufacturer's spare parts.